

Artikelnummer RST  
Article Code RST

Gewinde  
Entry Thread

D  
(mm)

L  
(mm)

H  
(mm)

VPE \*  
PU \*

99017550

M50x1.5

54.0

9.0

6.0

2

Material	Edelstahl 1.4305
O-Ring	NBR
Einsatztemperatur	-30°C bis+80°C
Schutzart	IP68
Zolltarif-Nummer	73269098
Gewicht	0.080 kg
EAN-Nummer	
RoHS (2015/863/EU)	konform
REACH/SVHC (Art. 33 1907/2006)	keine SVHC-Stoffe enthalten
Konfliktmineralien (Dodd-Frank Act)	keine Konfliktmineralien enthalten

Material	Stainless Steel 303
O-Ring	NBR
Operating Temperature	-30°C to+80°C
Protection Class	IP68
Customs Tariff Number	73269098
Weight	0.080 kg
EAN Code	
RoHS (2015/863/EU)	compliant
REACH/SVHC (Art. 33 1907/2006)	contain no SVHC substances
Konfliktmineralien (Dodd-Frank Act)	contain no conflict minerals



Zubehör

Accessories

VERSCHLUSSCHRAUBE  
RUND MIT O-RING / M  
PLUG ROUND WITH  
O-RING / M

Produktdokumentation  
Product Documentation

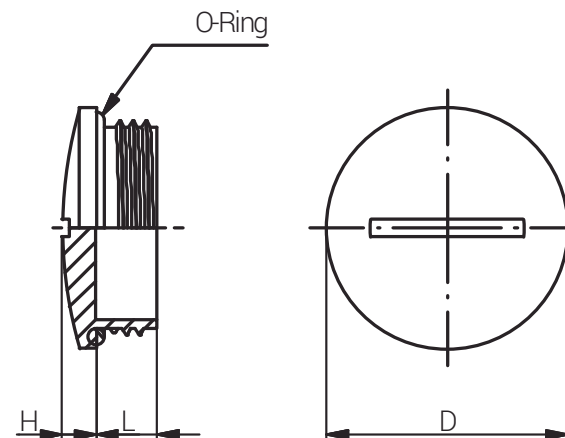

\* Mindestbestellmenge (MOQ) kann größer sein als Verpackungseinheit (VPE).

\* Minimum order quantity (MOQ) can be larger than packaging unit (PU).

RST Rabe-System-Technik und Vertriebs-GmbH  
Otto-Lilienthal-Strasse 19  
49134 Wallenhorst

DEUTSCHLAND

+49 5407 8766-0

+49 5407 8766-99

info@rst.eu

www.rst.eu