

Artikelnummer RST  
Article Code RST

Gewinde  
Entry Thread

D  
(mm)

L  
(mm)

H  
(mm)

VPE \*  
PU \*

69017409

PG 9

18.0

5.0

3.0

100

Material Messing, vernickelt  
O-Ring NBR  
Einsatztemperatur -30°C bis+80°C  
Schutzart IP68  
Zolltarif-Nummer 74198090  
Gewicht 0.005 kg  
EAN-Nummer 4054838007775  
RoHS (2015/863/EU) konf. (Inanspruchnahme Ausnahme 6c)  
REACH/SVHC (Art. 33 1907/2006) Blei enthalten  
Konfliktmineralien (Dodd-Frank Act) keine Konfliktmineralien enthalten

Material Nickel Plated Brass  
O-Ring NBR  
Operating Temperature -30°C to+80°C  
Protection Class IP68  
Customs Tariff Number 74198090  
Weight 0.005 kg  
EAN Code 4054838007775  
RoHS (2015/863/EU) compliant (claim exception 6c)  
REACH/SVHC (Art. 33 1907/2006) contain lead  
Konfliktmineralien (Dodd-Frank Act) contain no conflict minerals



Zubehör

Accessories

VERSCHLUSSCHRAUBE  
RUND MIT O-RING / PG  
PLUG ROUND WITH  
O-RING / PG

Produktdokumentation  
Product Documentation

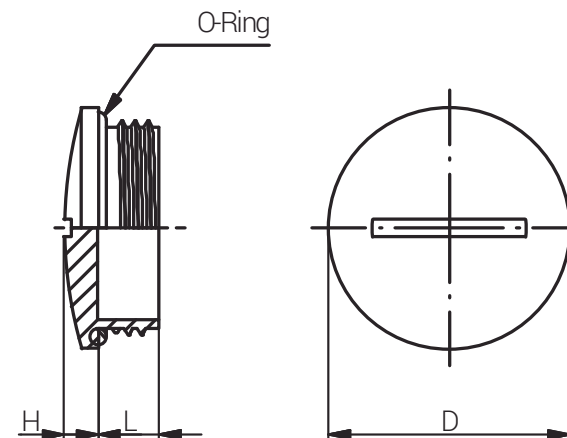

\* Mindestbestellmenge (MOQ) kann größer sein als Verpackungseinheit (VPE).

\* Minimum order quantity (MOQ) can be larger than packaging unit (PU).

RST Rabe-System-Technik und Vertriebs-GmbH  
Otto-Lilienthal-Strasse 19  
49134 Wallenhorst

DEUTSCHLAND

+49 5407 8766-0

+49 5407 8766-99

info@rst.eu

www.rst.eu