

Artikelnummer RST
Article Code RST

Gewinde
Entry Thread

D
(mm)

L
(mm)

H
(mm)

VPE *
PU *

69017429

PG 29

40.0

8.0

4.0

25

Material Messing, vernickelt
O-Ring NBR
Einsatztemperatur -30°C bis +80°C
Schutzart IP68
Zolltarif-Nummer 74198090
Gewicht 0.042 kg
EAN-Nummer 4054838007829
RoHS (2015/863/EU) konf. (Inanspruchnahme Ausnahme 6c)
REACH/SVHC (Art. 33 1907/2006) Blei enthalten
Konfliktminerale (Dodd-Frank Act) keine Konfliktminerale enthalten

Material Nickel Plated Brass
O-Ring NBR
Operating Temperature -30°C to +80°C
Protection Class IP68
Customs Tariff Number 74198090
Weight 0.042 kg
EAN Code 4054838007829
RoHS (2015/863/EU) compliant (claim exception 6c)
REACH/SVHC (Art. 33 1907/2006) contain lead
Konfliktminerale (Dodd-Frank Act) contain no conflict minerals



Zubehör

Accessories

VERSCHLUSSCHRAUBE
RUND MIT O-RING / PG
PLUG ROUND WITH
O-RING / PG

Produktdokumentation
Product Documentation

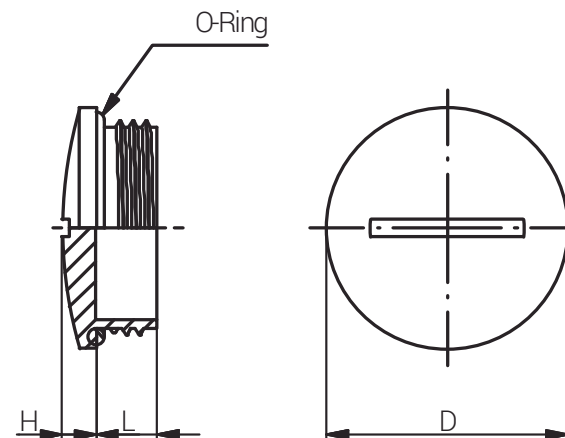

* Mindestbestellmenge (MOQ) kann größer sein als Verpackungseinheit (VPE).

* Minimum order quantity (MOQ) can be larger than packaging unit (PU).

RST Rabe-System-Technik und Vertriebs-GmbH
Otto-Lilienthal-Strasse 19
49134 Wallenhorst

DEUTSCHLAND

+49 5407 8766-0

+49 5407 8766-99

info@rst.eu

www.rst.eu