

Artikelnummer RST Article Code RST	Gewinde Entry Thread	Typ Type	L (mm)	D (mm)	H (mm)	VPE * PU *
RAL7035						
11007409	PG 9	B	6.5	19.1	3.0	100

Material	Polyamid 6 GF 30
Einsatztemperatur	-30°C bis +130°C
Entflammbarkeit (Polyamid 6 GF30)	UL-94 (V-0)
Schutzart gem. EN 62444:2013	IP54
Zolltarif-Nummer	39269097
Gewicht	0.001 kg
EAN-Nummer	4054838007492
RoHS (2015/863/EU)	konform
REACH/SVHC (Art. 33 1907/2006)	keine SVHC-Stoffe enthalten
Konfliktmineralien (Dodd-Frank Act)	keine Konfliktmineralien enthalten

Material	Polyamide 6 GF 30
Operating Temperature	-30°C to +130°C
Flammability (Polyamide 6 GF30)	UL-94 (V-0)
Protection Class rel. EN 62444:2013	IP54
Customs Tariff Number	39269097
Weight	0.001 kg
EAN Code	4054838007492
RoHS (2015/863/EU)	compliant
REACH/SVHC (Art. 33 1907/2006)	contain no SVHC substances
Konfliktmineralien (Dodd-Frank Act)	contain no conflict minerals



Zubehör

Accessories

VERSCHLUSSSCHRAUBE

RUND MIT SCHLITZ / PG

PLUG ROUND WITH SLOT / PG

Produktdokumentation
Product Documentation

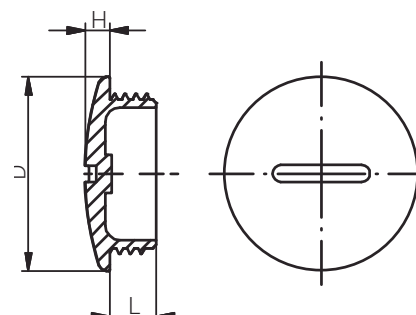
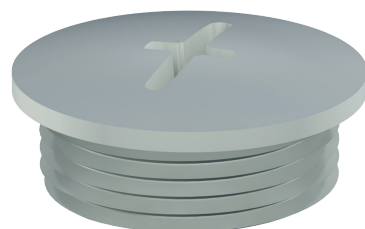

* Mindestbestellmenge (MOQ) kann größer sein als Verpackungseinheit (VPE).

* Minimum order quantity (MOQ) can be larger than packaging unit (PU).

RST Rabe-System-Technik und Vertriebs-GmbH
Otto-Lilienthal-Strasse 19
49134 Wallenhorst

DEUTSCHLAND

+49 5407 8766-0

+49 5407 8766-99

info@rst.eu

www.rst.eu