

Artikelnummer RST
Article Code RST

Gewinde
Entry Thread

Typ
Type

L
(mm)

D
(mm)

H
(mm)

VPE *
PU *

RAL9005

13007409

PG 9

B

6.5

19.1

3.0

100

Material Polyamid 6 GF 30
Einsatztemperatur -30°C bis +130°C
Entflammbarkeit (Polyamid 6 GF30) UL-94 (V-0)
Schutzart gem. EN 62444:2013 IP54
Zolltarif-Nummer 39269097
Gewicht 0.001 kg
EAN-Nummer 4054838007591
RoHS (2015/863/EU) konform
REACH/SVHC (Art. 33 1907/2006) keine SVHC-Stoffe enthalten
Konfliktminerale (Dodd-Frank Act) keine Konfliktminerale enthalten

Material Polyamide 6 GF 30
Operating Temperature -30°C to +130°C
Flammability (Polyamide 6 GF30) UL-94 (V-0)
Protection Class rel. EN 62444:2013 IP54
Customs Tariff Number 39269097
Weight 0.001 kg
EAN Code 4054838007591
RoHS (2015/863/EU) compliant
REACH/SVHC (Art. 33 1907/2006) contain no SVHC substances
Conflict minerals (Dodd-Frank Act) contain no conflict minerals



Zubehör

Accessories

VERSCHLUSSSCHRAUBE

RUND MIT SCHLITZ / PG

PLUG ROUND WITH SLOT / PG

Produktdokumentation
Product Documentation

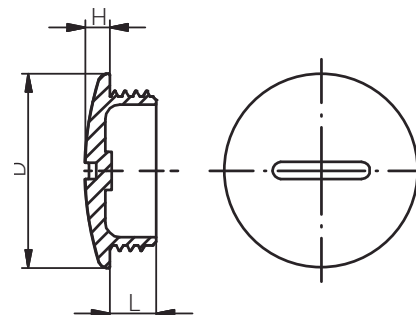

* Mindestbestellmenge (MOQ) kann größer sein als Verpackungseinheit (VPE).

* Minimum order quantity (MOQ) can be larger than packaging unit (PU).

RST Rabe-System-Technik und Vertriebs-GmbH
Otto-Lilienthal-Strasse 19
49134 Wallenhorst

DEUTSCHLAND

+49 5407 8766-0

+49 5407 8766-99

info@rst.eu

www.rst.eu